

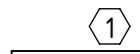
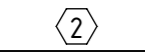
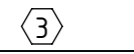
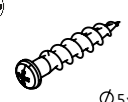
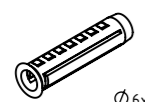

**NAKLIS HOME** English Français

# ETAGERE MINI-MÒ

Equipment provided  
Matériel fourni

Number of people needed  
Nombre de personnes nécessaires

 1	 2	 3
 $\varnothing 5 \times 35$	 $\varnothing 6 \times 35$	
x2	x2	x2



Necessary tools  
Outils nécessaires

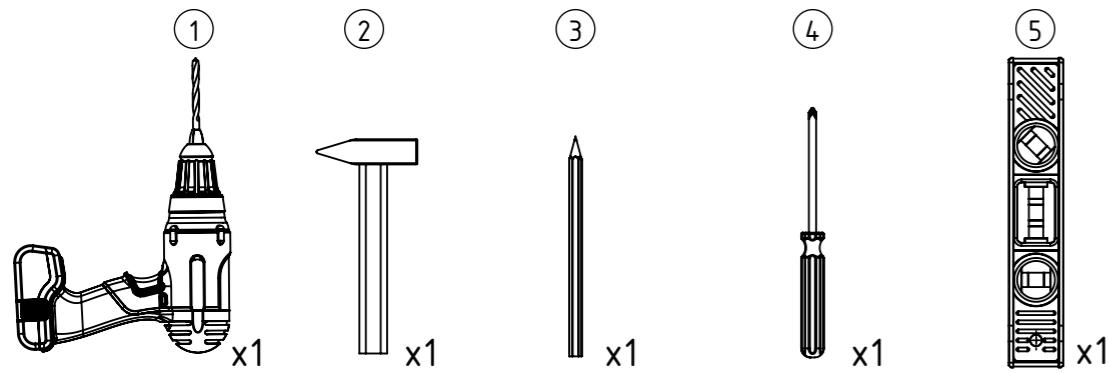

1 - Spot the fixing holes, drill the holes  $\varnothing 6\text{mm}$   
1 - Repérer les trous de fixation, percer les trous  $\varnothing 6\text{mm}$

- For shelves and mounting rails
- Pour étagères et rails

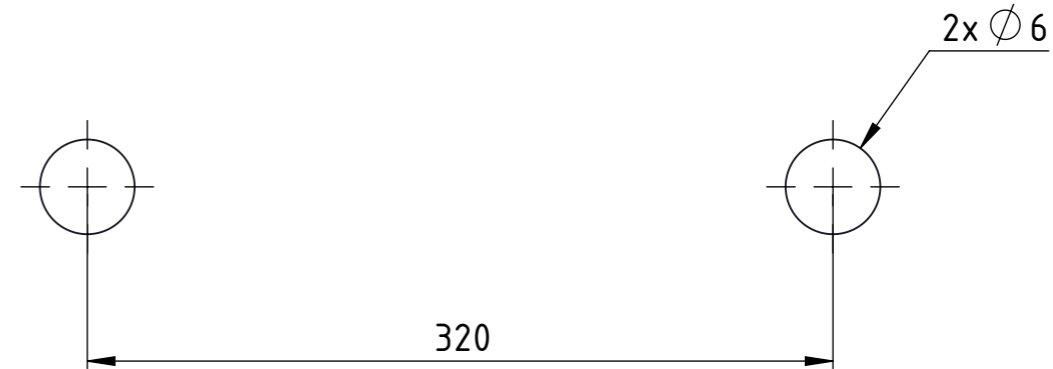

1

2 - Mount the shelves  
2 - Monter les étagères

RAIL MINI-R1/R2

RAIL MINI-R3/R4

2

